

DECLARATION OF PERFORMANCE

DoP 0186

for fischer Bolt Anchor FAZ II, FAZ II R, FAZ II HCR (Mechanical anchor for use in concrete)

EN

1. <u>Unique identification code of the product-type:</u>	DoP 0186		
2. <u>Intended use/es:</u>	Post-installed fastening in cracked or uncracked concrete.		
3. <u>Manufacturer:</u>	See appendix, especially annexes B1- B6 fischerwerke GmbH & Co. KG, Klaus-Fischer-Str. 1, 72178 Waldachtal, Germany		
4. <u>Authorised representative:</u>	–		
5. <u>System/s of AVCP:</u>	1		
6. <u>European Assessment Document:</u>	EAD 330232-00-0601		
European Technical Assessment:	ETA-05/0069; 2020-04-24		
Technical Assessment Body:	DIBt- Deutsches Institut für Bautechnik		
Notified body/ies:	1343 MPA Darmstadt / 2873 TU Darmstadt		
7. <u>Declared performance/s:</u>			
Mechanical resistance and stability (BWR 1)			
Characteristic resistance to tension load (static and quasi-static loading):	Resistance to steel failure: Annex C1 Resistance to pull- out failure: Annex C1	E _s = 210 000 MPa	
	Resistance to concrete cone failure: Annex C1 Robustness: Annex C1		
	Minimum edge distance and spacing: Annexes B3, B4 Edge distance to prevent splitting under load: Annex C1		
	Displacements under static and quasi-static loading: Annex C5		
Characteristic resistance to shear load (static and quasi-static loading):	Resistance to steel failure (shear load): Annex C2 Resistance to pry-out failure: Annex C2 Resistance to concrete edge failure: Annex C2 Displacements under static and quasi-static loading: Annex C5 Durability: Annexes A4, B1		
Characteristic resistance and displacements for seismic performance categories C1 and C2:	Resistance to steel failure: Annex C4 Resistance to pull-out failure: Annex C4 Fracture elongation: >8% Factor annular gap: Annex C4 Displacements: Annex C5		
Safety in case of fire (BWR 2)			
Reaction to fire:	Class (A1)		
Resistance to fire:	Fire resistance to steel failure (tension load): Annex C3 Fire resistance to pull-out failure (tension load): Annex C3 Fire resistance to steel failure (shear load): Annex C3		



8. Appropriate Technical Documentation and/or
Specific Technical Documentation:

The performance of the product identified above is in conformity with the set of declared performance/s. This declaration of performance is issued, in accordance with Regulation (EU) No 305/2011, under the sole responsibility of the manufacturer identified above.

Signed for and on behalf of the manufacturer by:

Thilo Pregartner, Dr.-Ing.
Tumlingen, 2020-05-15

Peter Schillinger, Dipl.-Ing.

This DoP has been prepared in different languages. In case there is a dispute on the interpretation the English version shall always prevail.

The Appendix includes voluntary and complementary information in English language exceeding the (language-neutrally specified) legal requirements.

Specific Part

1 Technical description of the product

The Fischer Bolt Anchor FAZ II is an anchor made of galvanised steel (FAZ II) or made of stainless steel (FAZ II R) or high corrosion resistant steel (FAZ II HCR) which is placed into a drilled hole and anchored by torque-controlled expansion.

The product description is given in Annex A.

2 Specification of the intended use in accordance with the applicable European Assessment Document

The performances given in Section 3 are only valid if the fastener is used in compliance with the specifications and conditions given in Annex B.

The verifications and assessment methods on which this European Technical Assessment is based lead to the assumption of a working life of the fastener of at least 50 years. The indications given on the working life cannot be interpreted as a guarantee given by the producer, but are to be regarded only as a means for choosing the right products in relation to the expected economically reasonable working life of the works.

3 Performance of the product and references to the methods used for its assessment

3.1 Mechanical resistance and stability (BWR 1)

Essential characteristic	Performance
Characteristic resistance to tension load (static and quasi-static loading)	See Annex B 3, C 1
Characteristic resistance to shear load (static and quasi-static loading)	See Annex C 2
Displacements (static and quasi-static loading)	See Annex C 5
Characteristic resistance and displacements for seismic performance categories C1 and C2	See Annex C 4
Durability	See Annex B 1

3.2 Safety in case of fire (BWR 2)

Essential characteristic	Performance
Reaction to fire	Class A1
Resistance to fire	See Annex C 3

4 Assessment and verification of constancy of performance (AVCP) system applied, with reference to its legal base

In accordance with the European Assessment Document EAD 330232-00-0601 the applicable European legal act is: [96/582/EC].

The system to be applied is: 1

Cone bolt manufactured by cold - forming:

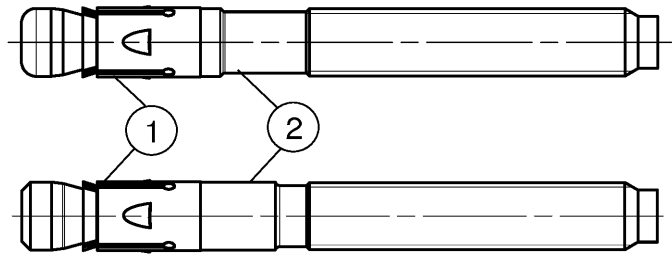

Cone bolt manufactured by turning:

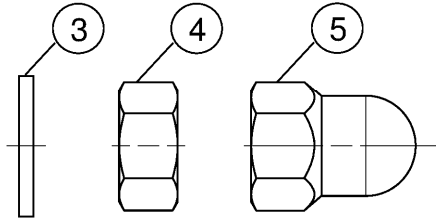

- ① Expansion sleeve
- ② Cone bolt (cold – formed or turned)
- ③ Washer
- ④ Hexagon nut
- ⑤ fischer FAZ II dome nut

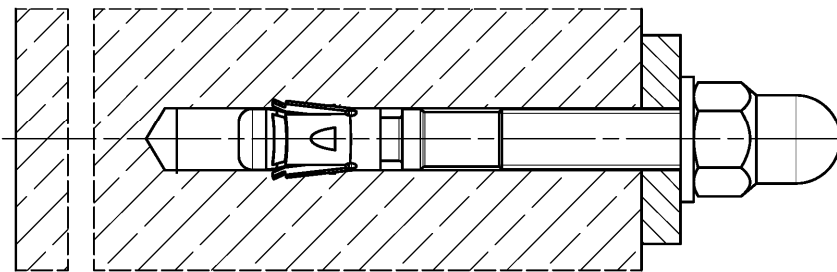
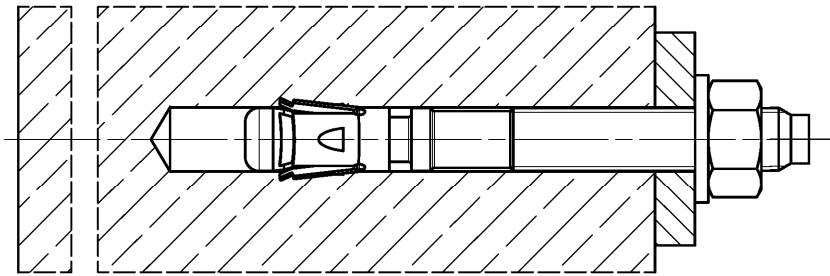

(Fig. not to scale)

fischer Bolt Anchor FAZ II, FAZ II R, FAZ II HCR

Product description
Installed condition

Annex A 1
Appendix 2/ 16

Product label and letter-code:

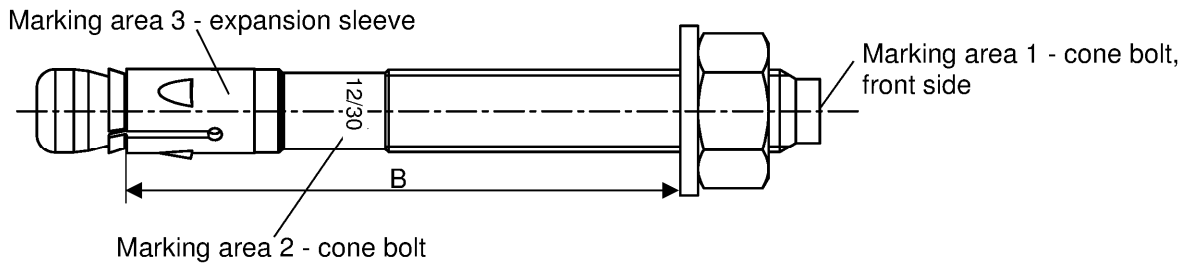

Product label, example:



Brand | type of fastener placed at marking area 2 or marking area 3

Thread size / max. thickness of the fixture (t_{fix}) identification R or HCR placed at marking area 2

- FAZ II: carbon steel, galvanized
- FAZ II R: stainless steel
- FAZ II HCR: high corrosion resistant steel

Table A2.1: Letter - code at marking area 1:

Marking	(a)	(b)	(c)	(d)	(A)	(B)	(C)	(D)	(E)	(F)	(G)	(H)	(I)	(K)	
Max. t_{fix}	5	10	15	20	5	10	15	20	25	30	35	40	45	50	
$B \geq [mm]$	M6	-			45	50	55	60	65	70	75	80	85	90	
	M8	40	45	-		50	55	60	65	70	75	80	85	90	95
	M10	45	50	55	60	65	70	75	80	85	90	95	100	105	110
	M12	55	60	65	70	75	80	85	90	95	100	105	110	115	120
	M16	70	75	80	85	90	95	100	105	110	115	120	125	130	135
	M20	-				105	110	115	120	125	130	135	140	145	150
	M24	-				130	135	140	145	150	155	160	165	170	175
Marking	(L)	(M)	(N)	(O)	(P)	(R)	(S)	(T)	(U)	(V)	(W)	(X)	(Y)	(Z)	
Max. t_{fix}	60	70	80	90	100	120	140	160	180	200	250	300	350	400	
$B \geq [mm]$	M6	100	110	120	130	140	160	180	200	220	240	290	340	390	440
	M8	105	115	125	135	145	165	185	205	225	245	295	345	395	445
	M10	120	130	140	150	160	180	200	220	240	260	310	360	410	460
	M12	130	140	150	160	170	190	210	230	250	270	320	370	420	470
	M16	145	155	165	175	185	205	225	245	265	285	335	385	435	485
	M20	160	170	180	190	200	220	240	260	280	300	350	400	450	500
	M24	185	195	205	215	225	245	265	285	305	325	375	425	475	525

Calculation existing h_{ef} for installed fasteners:

$$\text{existing } h_{ef} = B_{(\text{according to table A2.1})} - \text{existing } t_{fix}$$

Thickness of the fixture t_{fix} including thickness of fastener plate t and e.g. thickness of grout layer t_{grout} or other non-structural layers

(Fig. not to scale)

fischer Bolt Anchor FAZ II, FAZ II R, FAZ II HCR

Product description
Product label and letter code

Annex A 2
Appendix 3/ 16

Product dimensions

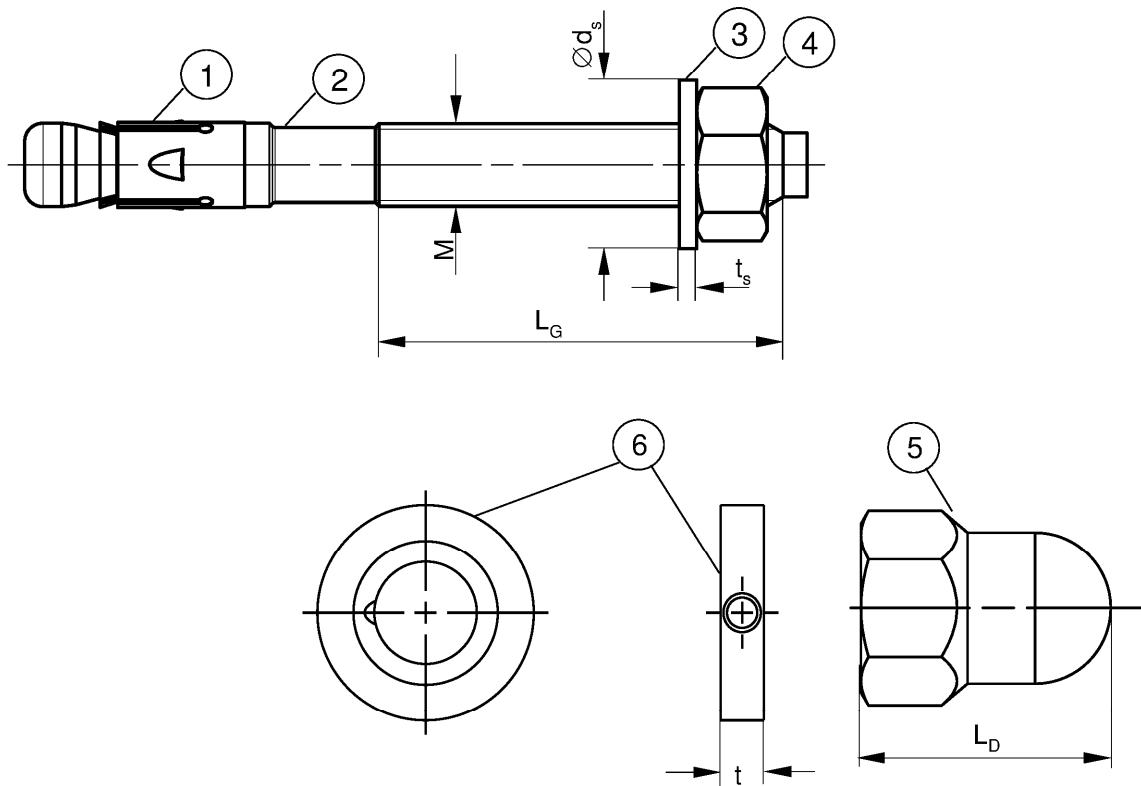

Table A3.1: Dimensions [mm]

Part	Designation		FAZ II, FAZ II R, FAZ II HCR						
			M6	M8	M10	M12	M16	M20	M24
1	Expansion sleeve	Sheet thickness	0,8	1,3	1,4	1,6	2,4		3,0
2	Cone bolt	Thread size M	6	8	10	12	16	20	24
		L_G	10	19	26	31	40	50	57
3	Washer	t_s	≥ 1,4	1,8	2,3	2,7		3,7	
		$\varnothing d_s$		11	15	19	23	29	36
4 & 5	Hexagon nut / fischer FAZ II	Wrench size	10	13	17	19	24	30	36
5	dome nut	L_D	≥	-	22	27	33	-	
6	fischer filling disc FFD	t	=	6			7	8	10

(Fig. not to scale)

fischer Bolt Anchor FAZ II, FAZ II R, FAZ II HCR

Product description
Dimensions

Annex A 3
Appendix 4/ 16

Table A4.1: Materials FAZ II (ISO 4042:2018/Zn5/An(A2K))

Part	Designation	Material
1	Expansion sleeve	Cold strip, EN 10139:2016 or stainless steel EN 10088:2014
2	Cone bolt	Cold form steel or free cutting steel
3	Washer	Cold strip, EN 10139:2016
4	Hexagon nut	Steel, property class min. 8, EN ISO 898-2:2012

Table A4.2: Materials FAZ II R

Part	Designation	Material
1	Expansion sleeve	Stainless steel EN 10088:2014
2	Cone bolt	
3	Washer	
4	Hexagon nut	Stainless steel EN 10088:2014; ISO 3506-2:2018; property class – min. 70

Table A4.3: Materials FAZ II HCR

Part	Designation	Material
1	Expansion sleeve	Stainless steel EN 10088:2014
2	Cone bolt	High corrosion resistant steel EN 10088:2014
3	Washer	
4	Hexagon nut	High corrosion resistant steel EN 10088:2014; ISO 3506-2:2018; property class – min. 70

(Fig. not to scale)

fischer Bolt Anchor FAZ II, FAZ II R, FAZ II HCR

Product description
Materials

Annex A 4
Appendix 5/ 16

Specifications of intended use

Anchorage subject to:

Size	FAZ II, FAZ II R, FAZ II HCR						
	M6	M8	M10	M12	M16	M20	M24
Static and quasi-static loads	✓						
Cracked and uncracked concrete							
Fire exposure							
Seismic performance category	C1	-			✓		
	C2 ¹⁾	-			✓		-

¹⁾ FAZ II HCR: Only valid for cold-formed version (according to Annex A1)

Base materials:

- Compacted reinforced and unreinforced normal weight concrete without fibres (cracked and uncracked) according to EN 206-1:2013+A1:2016
- Strength classes C20/25 to C50/60 according to EN 206-1:2013+A1:2016

Use conditions (Environmental conditions):

- Structures subject to dry internal conditions (FAZ II, FAZ II R, FAZ II HCR)
- Structures subject to external atmospheric exposure (including industrial and marine environment) and to permanently damp internal condition, if no particular aggressive conditions exist (FAZ II R, FAZ II HCR)
- Structures subject to external atmospheric exposure and permanently damp internal condition, if other particular aggressive conditions exist (FAZ II HCR)

Note: Particular aggressive conditions are e.g. permanent, alternating immersion in seawater or the splash zone of seawater, chloride atmosphere of indoor swimming pools or atmosphere with extreme chemical pollution (e.g. in desulphurization plants or road tunnels where deicing materials are used)

Design:

- Anchorages are to be designed under the responsibility of an engineer experienced in anchorages and concrete work
- Verifiable calculation notes and drawings are to be prepared taking account of the loads to be anchored. The position of the anchor is indicated on the design drawings (e.g. position of the anchor relative to reinforcement or to supports, etc.)
- Design of fastenings according to EN 1992-4:2018 and EOTA Technical Report TR 055
- For effective embedment depth $h_{ef} < 40$ mm only statically indeterminate fixings (e.g. light-weight suspended ceilings with internal exposure) are covered by the ETA

fischer Bolt Anchor FAZ II, FAZ II R, FAZ II HCR

Intended Use
Specifications

Annex B 1

Appendix 6/ 16

Table B2.1: Installation parameters

Size	FAZ II, FAZ II R, FAZ II HCR						
	M6	M8	M10	M12	M16	M20	M24
Nominal drill hole diameter $d_0 =$	6	8	10	12	16	20	24
Maximum bit diameter with hammer or hollow drilling $d_{cut,max}$ [mm]	6,40	8,45	10,45	12,5	16,5	20,55	24,55
Maximum bit diameter with diamond drilling	-	8,15		12,25	16,45	20,50	24,40
Overall fastener embedment depth in the concrete $h_{nom} \geq (L)$ [mm]	46,5 (6,5)	44,5 (9,5)	52,0 (12)	63,5 (13,5)	82,5 (17,5)	120 (20)	148,5 (23,5)
Depth of drill hole to deepest point $h_1 \geq$	Existing $h_{ef} + L = h_{nom}$ $h_{nom} + 5$					$h_{nom} + 10$	
Diameter of clearance hole in the fixture $d_f \leq$ [mm]	7	9	12	14	18	22	26
Required setting torque $T_{inst} =$ [Nm]	8	20	45	60	110	200	270
Excess length after hammering-in the cone bolt (for fischer dome nut applications according to Annex B6) $O =$ [mm]	-		12	16	20	-	

Setting gauge FAZ II SL-H
for anchor with fischer FAZ II dome nut:

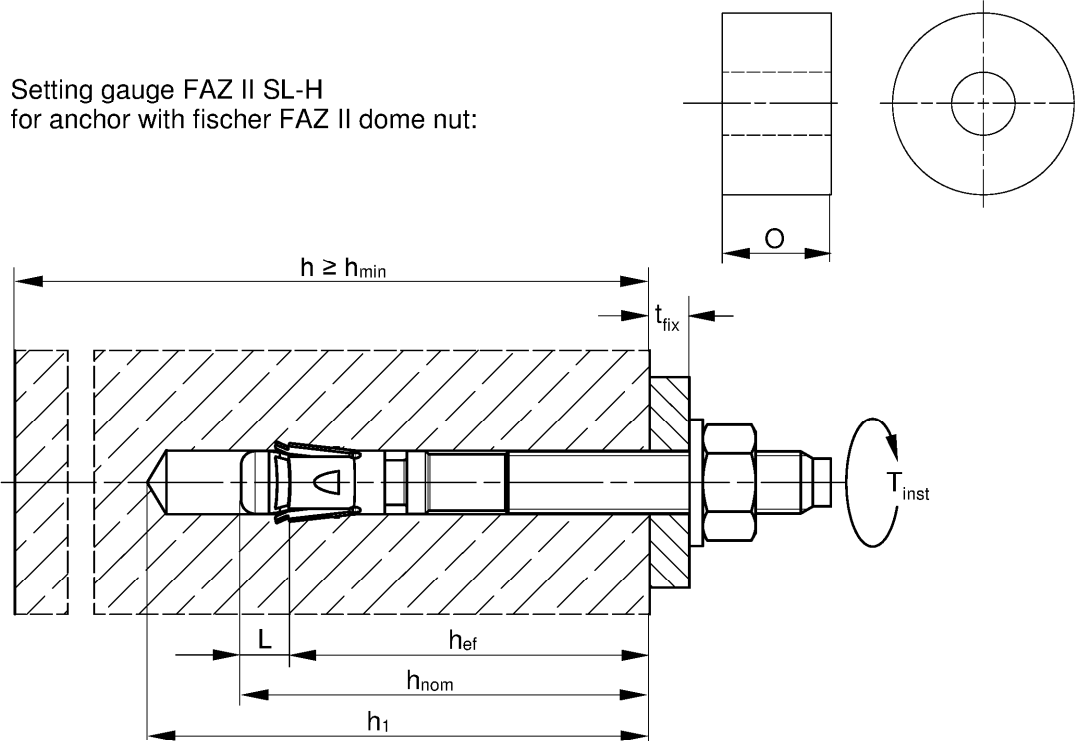

- h_{ef} = Effective embedment depth
- t_{fix} = Thickness of the fixture
- h_1 = Depth of drill hole to deepest point
- h = Thickness of the concrete member
- h_{min} = Minimum thickness of concrete member
- h_{nom} = Overall fastener embedment depth in the concrete
- T_{inst} = Required setting torque

(Fig. not to scale)

fischer Bolt Anchor FAZ II, FAZ II R, FAZ II HCR

Intended Use
Installation parameters

Annex B 2
Appendix 7/ 16

Table B3.1: Minimum thickness of concrete members, minimum spacing and minimum edge distance

Size	FAZ II, FAZ II R, FAZ II HCR							
	M6	M8	M10	M12	M16	M20	M24	
Minimum edge distance								
Uncracked concrete	C _{min}	45	40	45	55	65	95	135
Cracked concrete		85	100					
Corresponding spacing	s [mm]	according to Annex B4						
Minimum thickness of concrete member	h _{min}	80		100	140	160	200	
Thickness of concrete member	h ≥	max. {h _{min} ; h ₁ ¹⁾ + 30}			max. {h _{min} ; h ₁ ¹⁾ + 2 · d _o }			
Minimum spacing								
Uncracked concrete	S _{min}	35	40	40	50	65	95	100
Cracked concrete		35						
Corresponding edge distance	c [mm]	according to Annex B4						
Minimum thickness of concrete member	h _{min}	80		100	140	160	200	
Thickness of concrete member	h ≥	max. {h _{min} ; h ₁ ¹⁾ + 30}			max. {h _{min} ; h ₁ ¹⁾ + 2 · d _o }			
Minimal splitting area								
Uncracked concrete	A _{sp,req} [·1000 mm ²]	5,1	18	37	54	67	100	117,5
Cracked concrete		1,5	12	27	40	50	77	87,5

¹⁾ h₁ according to Annex B2

Splitting failure applied for minimum edge distance and spacing in dependence of the h_{ef}

For the calculation of minimum spacing and minimum edge distance of anchors in combination with different embedment depths and thicknesses of concrete members the following equation shall be fulfilled:

$$A_{sp,req} < A_{sp,ef}$$

A_{sp,req} = required splitting area

A_{sp,ef} = effective splitting area (according to Annex B4)

fischer Bolt Anchor FAZ II, FAZ II R, FAZ II HCR

Intended Use

Minimum thickness of member, minimum spacing and edge distance

Annex B 3

Appendix 8/ 16

Table B4.1: Effective splitting area $A_{sp,ef}$ with member thickness $h > h_{ef} + 1,5 \cdot c$ and $h \geq h_{min}$

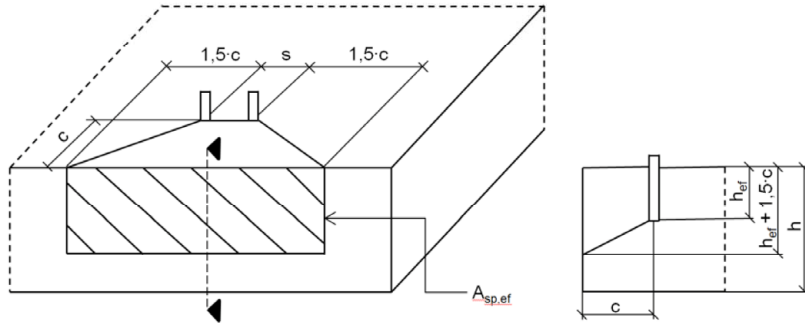

Single anchor and group of anchors with $s > 3 \cdot c$	$A_{sp,ef} = (6 \cdot c) \cdot (h_{ef} + 1,5 \cdot c)$	[mm ²]	with $c \geq c_{min}$
Group of anchors with $s \leq 3 \cdot c$	$A_{sp,ef} = (3 \cdot c + s) \cdot (h_{ef} + 1,5 \cdot c)$	[mm ²]	with $c \geq c_{min}$ and $s \geq s_{min}$

Table B4.2: Effective splitting area $A_{sp,ef}$ with member thickness $h \leq h_{ef} + 1,5 \cdot c$ and $h \geq h_{min}$

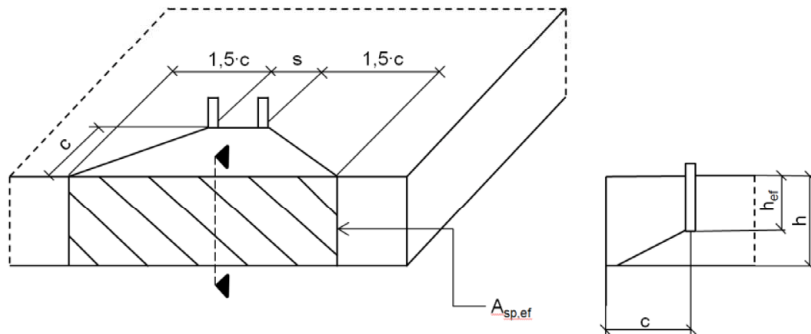

Single anchor and group of anchors with $s > 3 \cdot c$	$A_{sp,ef} = 6 \cdot c \cdot \text{existing } h$	[mm ²]	with $c \geq c_{min}$
Group of anchors with $s \leq 3 \cdot c$	$A_{sp,ef} = (3 \cdot c + s) \cdot \text{existing } h$	[mm ²]	with $c \geq c_{min}$ and $s \geq s_{min}$

Edge distance and axial spacing shall be rounded to at least 5 mm

(Fig. not to scale)

fischer Bolt Anchor FAZ II, FAZ II R, FAZ II HCR

Intended Use

Minimum thickness of member, minimum spacings and edge distances

Annex B 4





Appendix 9/ 16

Installation instructions:

- Anchor installation carried out by appropriately qualified personnel and under the supervision of the person responsible for technical matters of the site
- Use of the anchor only as supplied by the manufacturer without exchanging the components of the anchor
Exception: fischer FAZ II dome nut.
- Checking before placing the anchor to ensure that the strength class of the concrete in which the anchor is to be placed is in the range given and is not lower than that of the concrete to which the characteristic loads apply
- Check of concrete being well compacted, e.g. without significant voids
- Hammer, hollow or diamond drilling according to Annex B5
- Drill hole created perpendicular $\pm 5^\circ$ to concrete surface, positioning without damaging the reinforcement
- In case of aborted hole: new drilling at a minimum distance twice the depth of the aborted drill hole or smaller distance if the aborted drill hole is filled with high strength mortar and if under shear or oblique tension load it is not in the direction of load application
- It must be ensured that in case of fire local spalling of the concrete cover does not occur
- Fastenings in stand-off installation or with a grout layer under seismic action are not covered
- In case of seismic applications the fastener shall be positioned outside of critical regions (e.g. plastic hinges) of the concrete structure

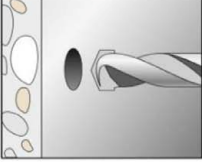
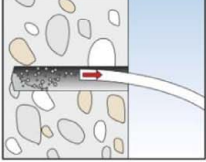
Installation instructions: Drilling and cleaning the hole

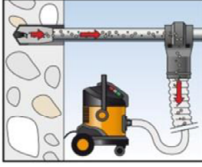
Types of drills and cleaning

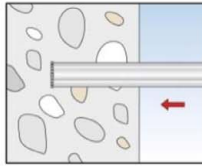
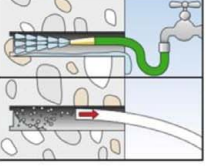
Hammer drill		 1: Drill the hole	 2: Clean the hole
Hollow drill		 1: Drill the hole with automatic cleaning	-
Diamond drill, for non seismic applications only and \geq drill $\varnothing 8$		 1: Drill the hole	 2: Clean the hole

fischer Bolt Anchor FAZ II, FAZ II R, FAZ II HCR

Intended Use
Installation instructions

Annex B 5
Appendix 10/ 16

Installation instructions: Installation of the anchor

HEXAGON NUT:

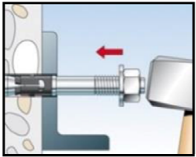

3: Set the fastener

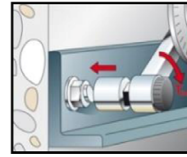

4: Apply T_{inst}

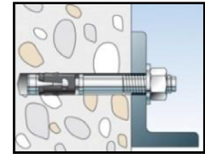

5: Installed fastener

fischer FAZ II DOME NUT:

Option 1: Push through installation with setting gauge SL-H:

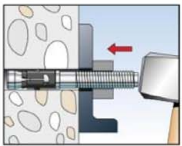

3: Set the fastener using setting gauge



4: Check offset

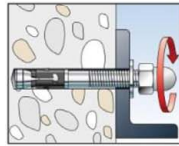

5: Turn on the washer and fischer FAZ II dome nut

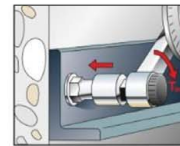

6: Apply T_{inst}

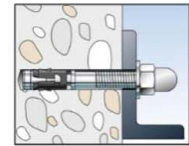

7: Installed fastener

Option 2: Push through installation with hexagon nut:

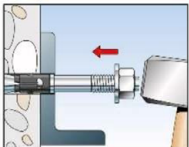

3: Set the fastener

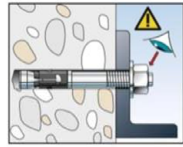

4: check setting position: Visible one turn of a thread

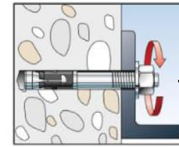

4.1: Remove nut

fischer FILLING DISC FFD optional for seismic C2 application or minimizing the annular gap:

Optional	<p>The gap between bolt and fixture may be filled with mortar (compressive strength $\geq 50 \text{ N/mm}^2$ e.g. FIS SB) after step 7 (for eliminating the annular gap). The filling disc is additional to the standard washer. The thickness of the filling disc must be considered for definition of t_{fix}. Countersunk of the filling disc in direction to the anchor plate.</p>
----------	---

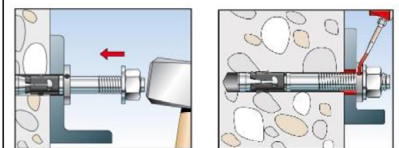

fischer Bolt Anchor FAZ II, FAZ II R, FAZ II HCR

Intended Use
Installation instructions

Annex B 6
Appendix 11/ 16

Table C1.1: Characteristic tension resistance under static and quasi-static action

Size	FAZ II, FAZ II R, FAZ II HCR												
	M6	M8	M10	M12	M16	M20	M24						
Steel failure													
Characteristic resistance	FAZ II	$N_{Rk,s}$ [kN]	7,6	16,6	28,3	43,2	67,0	123,3	176,7				
	FAZ II R/HCR		11,4	17,0	29,0	44,3	70,6	124,9	183,6				
Partial factor for steel failure	$\gamma_{Ms}^{1)}$	[-]	1,5										
Pullout failure													
Effective embedment depth for calculation	h_{ef} [mm]	40	35 - < 45	45	40 - 60	50 - 70	65 - 85	100	125				
Characteristic resistance in cracked concrete C20/25	$N_{Rk,p}$ [kN]	1,5	5,5	8	13	20	27,0	34,4	48,1				
Characteristic resistance in uncracked concrete C20/25		10,5	14	20	22	38,6	49,2	68,8					
Increasing factors for $N_{Rk,p}$ for cracked and uncracked concrete	ψ_c	C25/30	1,12										
		C30/37	1,22										
		C35/45	1,32										
		C40/50	1,41										
		C45/55	1,50										
		C50/60	1,58										
Installation factor	γ_{inst}	[-]	1,0										
Concrete cone and splitting failure													
Factor for uncracked concrete	$k_{ucr,N}$	[-]	11,0 ²⁾										
Factor for cracked concrete	$k_{cr,N}$		7,7 ²⁾										
Characteristic spacing	$s_{cr,N}$	[mm]	$3 \cdot h_{ef}$										
Characteristic edge distance	$c_{cr,N}$		$1,5 \cdot h_{ef}$										
Spacing	$s_{cr,sp}$	$2 \cdot c_{cr,sp}$											
Edge distance for h = 80	$c_{cr,sp}$ [mm]	40	$2,4 \cdot h_{ef}$	$2 \cdot h_{ef}$	-	-							
Edge distance for h = 100			$2 \cdot h_{ef}$	$2,4 \cdot h_{ef}$	$2 \cdot h_{ef}$								
Edge distance for h = 120				$1,9 \cdot h_{ef}$	$2,1 \cdot h_{ef}$	-							
Edge distance for h = 140			$1,5 \cdot h_{ef}$		$2 \cdot h_{ef}$					$2,4 \cdot h_{ef}$		-	
Edge distance for h = 160					$2,2 \cdot h_{ef}$								
Edge distance for h = 200			$2,2 \cdot h_{ef}$										
Characteristic resistance to splitting			$N_{Rk,sp}^0$ [kN]	$\min \{N_{Rk,c}^0; N_{Rk,p}\}^{3)}$									

1) In absence of other national regulations

2) Based on concrete strength as cylinder strength

3) $N_{Rk,c}^0$ according to EN 1992-4:2018

fischer Bolt Anchor FAZ II, FAZ II R, FAZ II HCR

Performances

Characteristic values of resistance under tension loads

Annex C 1

Appendix 12/ 16

Table C2.1: Characteristic values of **shear** resistance under static and quasi-static action

Size	FAZ II, FAZ II R, FAZ II HCR								
	M6	M8	M10	M12	M16	M20	M24		
Steel failure without lever arm									
Characteristic resistance	FAZ II	$V^{0}_{RK,s}$ [kN]	5,9	13,6	21,4	30,6	55,0	81,4	110,1
	FAZ II R/HCR		8,8	16,8	26,5	38,3	69,8	106,3	148,5
Partial factor for steel failure		$\gamma_{Ms}^{1)}$	1,25						
Factor for ductility		k_7	1,0						
Steel failure with lever arm and Concrete pryout failure									
Effective embedment depth for calculation		h_{ef} [mm]	40	45	60	70	85	100	125
Characteristic bending resistance	FAZ II	$M^{0}_{RK,s}$ [Nm]	11,4	26	52	92	233	513	865
	FAZ II R/HCR		10,7	29	59	100	256	519	898
Factor for pryout failure		k_8 [-]	2,6	2,8	3,2		3,0	2,6	2,4
Effective embedment depth for calculation		h_{ef} [mm]		35 - < 45	40 - < 60	50 - < 70	65 - < 85		
Characteristic bending resistance	FAZ II	$M^{0}_{RK,s}$ [Nm]	-	20	44	92	184	-	-
	FAZ II R/HCR		21	45	100	193			
Factor for pryout failure		k_8 [-]	2,5	2,6	3,1	3,2			
Partial factor for steel failure		$\gamma_{Ms}^{1)}$	1,25						
Factor for ductility		k_7	1,0						
Concrete edge failure									
Effective embedment depth for calculation		$l_f =$ [mm]	h_{ef}						
Outside diameter of a fastener		d_{nom}	6	8	10	12	16	20	24

1) In absence of other national regulations

fischer Bolt Anchor FAZ II, FAZ II R, FAZ II HCR

Performances

Characteristic values of resistance under shear loads

Annex C 2

Appendix 13/ 16

Table C3.1: Characteristic values of tension resistance under fire exposure

Size		FAZ II, FAZ II R, FAZ II HCR							
		M6	M8	M10	M12	M16	M20	M24	
$h_{ef} \geq$ [mm]		40	35 / 45	40 / 60	50 / 70	65 / 85	100	125	
Characteristic resistance steel failure	$N_{Rk,s,fi}$	R30	0,6 ¹⁾ / 0,9 ²⁾	1,4	2,8	5,0	9,4	14,7	21,1
		R60	0,4 ¹⁾ / 0,9 ²⁾	1,2	2,3	4,1	7,7	12,0	17,3
		R90	0,3 ¹⁾ / 0,9 ²⁾	0,9	1,9	3,2	6,0	9,4	13,5
		R120	0,2 ¹⁾ / 0,7 ²⁾	0,8	1,6	2,8	5,2	8,1	11,6
Characteristic resistance Concrete cone failure	$N_{Rk,c,fi}$	R30 - R90	$7,7 \cdot h_{ef}^{1,5} \cdot (20)^{0,5} \cdot h_{ef} / 200 / 1000$						
		R120	$7,7 \cdot h_{ef}^{1,5} \cdot (20)^{0,5} \cdot h_{ef} / 200 / 1000 \cdot 0,8$						
Characteristic resistance pullout failure	$N_{Rk,p,fi}$	R30	0,4	0,9 / 2,0	2,2 / 3,3	3,0 / 5,0	4,5 / 6,8	8,6	12,0
		R60		0,8 / 2,0					
		R90	0,5 / 2,0	1,7 / 2,6	2,4 / 4,0	3,6 / 5,4	6,9	9,6	
		R120	0,3						

Table C3.2: Characteristic values of shear resistance under fire exposure

Size		R30		R60		
FAZ II, FAZ II R, FAZ II HCR		$V_{Rk,s,fi,30}$ [kN]	$M^0_{Rk,s,fi,30}$ [Nm]	$V_{Rk,s,fi,60}$ [kN]	$M^0_{Rk,s,fi,60}$ [Nm]	
M6	$h_{ef} \geq$	40	0,6 ¹⁾ / 0,9 ²⁾	0,4 ¹⁾ / 0,9 ²⁾	0,3 ¹⁾ / 0,1 ²⁾	
M8		35	1,8	1,6	1,2	
M10		40	3,6		2,9	3,0
M12		50	6,3	7,8	4,9	6,4
M16		65	11,7	19,9	9,1	16,3
M20		100	18,2	39,0	14,2	31,8
M24		125	26,3	67,3	20,5	55,0

Size		R90		R120		
FAZ II, FAZ II R, FAZ II HCR		$V_{Rk,s,fi,90}$ [kN]	$M^0_{Rk,s,fi,90}$ [Nm]	$V_{Rk,s,fi,120}$ [kN]	$M^0_{Rk,s,fi,120}$ [Nm]	
M6	$h_{ef} \geq$	40	0,3 ¹⁾ / 0,9 ²⁾	0,2 ¹⁾ / 0,7 ²⁾	0,2 ¹⁾ / 0,1 ²⁾	
M8		35	1,3	1,2	0,8	
M10		40	2,2	2,4	1,9	2,1
M12		50	3,5	5,0	2,8	4,3
M16		65	6,6	12,6	5,3	11,0
M20		100	10,3	24,6	8,3	21,4
M24		125	14,8	42,6	11,9	37,0

Concrete pycout failure according to EN 1992-4:2018

Table C3.3: Minimum spacings and minimum edge distances of anchors under fire exposure for tension and shear load

Size		FAZ II, FAZ II R, FAZ II HCR						
		M6	M8	M10	M12	M16	M20	M24
Spacing	s_{min}	Annex B3						
Edge distance	c_{min} [mm]	$c_{min} = 2 \cdot h_{ef}$, for fire exposure from more than one side $c_{min} \geq 300$ mm						

1) FAZ II

2) FAZ II R / HCR

fischer Bolt Anchor FAZ II, FAZ II R, FAZ II HCR

Performances

Characteristic values of resistance under fire exposure

Annex C 3

Appendix 14/ 16

Table C4.1: Characteristic values of tension and shear resistance under seismic action category C1

Size	FAZ II, FAZ II R, FAZ II HCR						
	M6	M8	M10	M12	M16	M20	M24
Length of anchor L_{max} [mm]	-	167	186	221	285	394	477
Effective embedment depth h_{ef} [mm]	-	45	40 - 60	50 - 70	65 - 85	100	125
With filling of the annular gap α_{gap} [-]	1,0						
Steel failure							
Characteristic resistance tension load C1 $N_{Rk,s,C1}$ [kN]	-	16,0	27,0	41,0	66,0	111,0	150,0
Partial factor for steel failure $\gamma_{Ms,C1}^{1)}$ [-]	1,5						
Pullout failure							
Characteristic resistance tension load in cracked concrete C1 $N_{Rk,p,C1}$ [kN]	-	4,6	8,0	16,0	28,2	36,0	50,3
Installation factor γ_{Inst} [-]	1,0						
Steel failure without lever arm							
Characteristic resistance shear load C1 $V_{Rk,s,C1}$ [kN]	-	11	17	27	47	56	69
Partial factor for steel failure $\gamma_{Ms,C1}^{1)}$ [-]	1,25						

¹⁾ In absence of other national regulations

Table C4.2: Characteristic values of tension and shear resistance under seismic action category C2

Size	FAZ II, FAZ II R, FAZ II HCR ¹⁾						
	M6	M8	M10	M12	M16	M20	M24
Length of anchor L_{max} [mm]	-		186	221	285	394	-
With filling of the annular gap α_{gap} [-]	1,0						
Steel failure							
Characteristic resistance tension load C2 $N_{Rk,s,C2}$ [kN]	-		27	41	66	111	-
Partial factor for steel failure $\gamma_{Ms,C2}^{2)}$ [-]	1,5						
Pullout failure							
Characteristic resistance tension load in cracked concrete C2 $N_{Rk,p,C2}$ [kN]	h_{ef} [mm]	-	60	70	85	100	-
	$N_{Rk,p,C2}$ [kN]	-	5,1	7,4	21,5	30,7	-
	h_{ef} [mm]	-	40-59	50-69	65-84		-
	$N_{Rk,p,C2}$ [kN]	-	2,7	4,4	16,4		-
Installation factor γ_{Inst} [-]	1,0						
Steel failure without lever arm							
Characteristic resistance shear load C2 $V_{Rk,s,C2}$ [kN]	h_{ef} [mm]	-	60	70	85	100	-
	$V_{Rk,s,C2}$ [kN]	-	10,0	17,4	27,5	39,9	-
	h_{ef} [mm]	-	40-59	50-69	65-84		-
	$V_{Rk,s,C2}$ [kN]	-	7,0	12,7	22,0		-
Partial factor for steel failure $\gamma_{Ms,C2}^{2)}$ [-]	1,25						

¹⁾ FAZ II HCR: Only valid for cold-formed version (according to Annex A1)

²⁾ In absence of other national regulations

fischer Bolt Anchor FAZ II, FAZ II R, FAZ II HCR

Performances

Characteristic values of resistance under tension and shear loads under seismic action

Annex C 4

Appendix 15/ 16

Table C5.1: Displacements under static and quasi static tension loads

Size	FAZ II, FAZ II R, FAZ II HCR						
	M6	M8	M10	M12	M16	M20	M24
Displacement – factor for tensile load¹⁾							
δ_{N0} - factor	0,13	0,22	0,12	0,09	0,08	0,07	0,05
_____ in cracked concrete							
$\delta_{N\infty}$ - factor	1,00	0,78	0,40	0,19	0,09		0,07
_____ [mm/kN]							
δ_{N0} - factor	0,16	0,07	0,05	0,06		0,05	0,04
_____ in uncracked concrete							
$\delta_{N\infty}$ - factor	0,24	0,29	0,21	0,14	0,10	0,06	0,05

Table C5.2: Displacements under static and quasi static shear loads

Size	FAZ II						
	M6	M8	M10	M12	M16	M20	M24
Displacement – factor for shear load²⁾							
δ_{V0} - factor	0,6	0,35	0,37	0,27	0,10	0,09	0,07
$\delta_{V\infty}$ - factor	0,9	0,52	0,55	0,40	0,14	0,15	0,11
_____ in cracked and uncracked concrete							
δ_{V0} - factor	FAZ II R, FAZ II HCR						
_____ [mm/kN]							
δ_{V0} - factor	0,6	0,23	0,19	0,18	0,10	0,11	0,07
$\delta_{V\infty}$ - factor	0,9	0,27	0,22	0,16	0,11	0,05	0,09

1) Calculation of effective displacement:

$$\delta_{N0} = \delta_{N0} - \text{factor} \cdot N_{ED}$$

$$\delta_{N\infty} = \delta_{N\infty} - \text{factor} \cdot N_{ED}$$

(N_{ED} : Design value of the applied tension force)

2) Calculation of effective displacement:

$$\delta_{V0} = \delta_{V0} - \text{factor} \cdot V_{ED}$$

$$\delta_{V\infty} = \delta_{V\infty} - \text{factor} \cdot V_{ED}$$

(V_{ED} : Design value of the applied shear force)

Table C5.3: Displacements under tension loads for category C2 for all embedment depths

Size	FAZ II, FAZ II R, FAZ II HCR						
	M6	M8	M10	M12	M16	M20	M24
Displacement DLS $\delta_{N,C2(DLS)}$			2,7	4,4		5,6	
Displacement ULS $\delta_{N,C2(ULS)}$			11,5	13,0	12,3	14,4	

Table C5.4: Displacements under shear loads for category C2 for all embedment depths

Size	FAZ II, FAZ II R, FAZ II HCR						
	M6	M8	M10	M12	M16	M20	M24
Displacement DLS $\delta_{V,C2(DLS)}$			4,1	4,7	5,5	4,8	
Displacement ULS $\delta_{V,C2(ULS)}$			6,2	7,8	10,1	11,2	

fischer Bolt Anchor FAZ II, FAZ II R, FAZ II HCR

Performances

Displacements under tension and shear loads

Annex C 5

Appendix 16/ 16