

INSTALLATION MANUAL | Dea Eros M PF plafone

PREPARATIONS:

Before assembling the luminaire, carefully read these instructions to make sure the luminaire functions correctly and safely • The mains isolator on the consumer unit/fuse board must be in "OFF" position before commencing any electrical work • The luminaires should be mounted on a flat, smooth surface • With all painted/plated products some shade and finishing variation may occur, please make sure the luminaires are checked before installation • The luminaire must not be modified. Modifying the luminaire in any way invalidates the guarantee of conformity with standards and directives in force and it could make the actual luminaire hazardous • Before connecting the luminaire, make sure the mains power supply corresponds to the power indicated on the luminaire label • Never cover the luminaire during use. Luminaires classified for indoor use must never be used outdoors even if they are protected from the elements • The manufacturer reserves the right to change the product specification without prior notice.

! PLEASE NOTE: Installation must be done by qualified and trained personnel !



PREVIEW

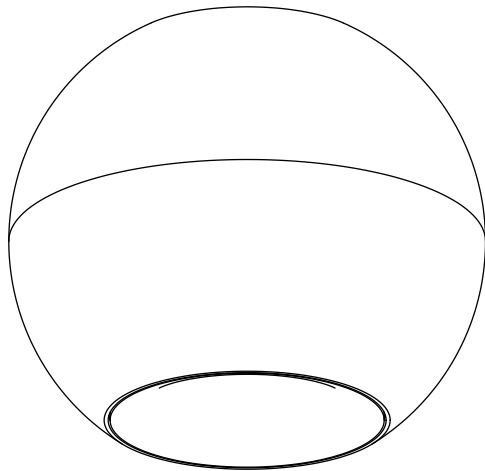

A

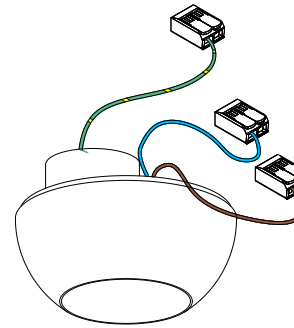
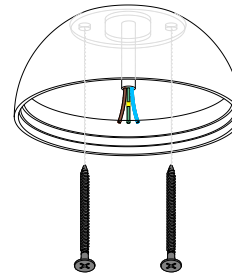

B

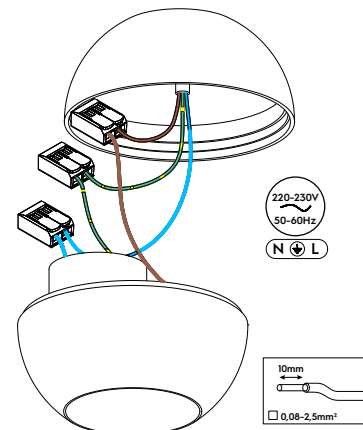

C

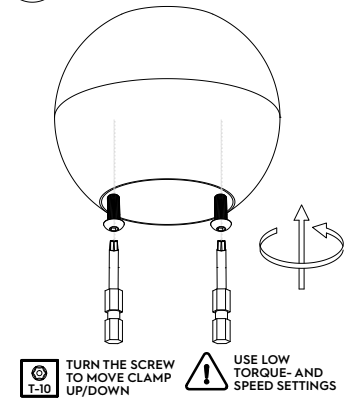

D

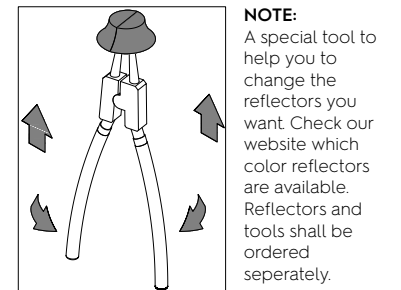
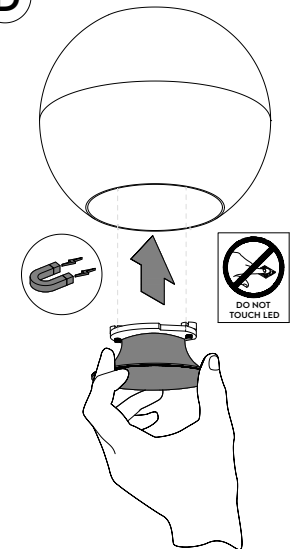

NOTE:
A special tool to help you to change the reflectors you want. Check our website which color reflectors are available. Reflectors and tools shall be ordered separately.