

WARRIOR LED SPI Heavy Industrial Mid Power Floodlight

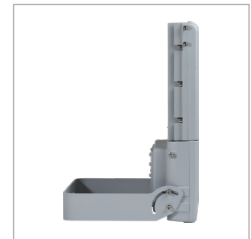

Power / Performance

High lumen output up to 20,588 lumens, designed to directly replace traditional discharge light sources up to 250W SON.



Robust and Durable

Robust and durable construction from marine grade aluminium and with a wide operating temperature for even the most challenging conditions.



Intelligent Emergency

Self-testing emergency battery providing up to 3 hours emergency back-up.



Multiple Beam Angles

Available with a range of beam patterns to effectively light up large open areas such as service yards. The use of secondary optics means no loss of output on wider angles.

5 YEAR WARRANTY

All Raytec luminaires are provided with an industry leading 5 year warranty and have an expected useful life in excess of 10 years. See Warranty Statement for details.



Technical Specifications

Electrical	5K	7.5K	10K	12.5K	15K	20K
Input	150-264V 50/60Hz AC/DC 110V variant available - please contact Raytec					
Power	40W	60W	80W	100W	120W	150W
Termination	Incoming terminal block suitable for looping 4 core 4mm ² cable					
Power Factor	>0.95					
Cable Entries	2xM20 as standard (other entries available upon request), dispatched complete with one blanking plug					

Optical	5K	7.5K	10K	12.5K	15K	20K
Beam Patterns	30° x 30° or 60° x 60° or 90° x 90° or 120° x 15° or 10° x 10°					
Lumen Output (upto)	5,149lm	7,663lm	10,298lm	12,873lm	15,325lm	20,588lm
LED Type	Platinum Elite SMT LEDs					
Number of LEDs	24	24	48	48	48	48
CRI	70+					
Colour Temperature	5,700K					

Mechanical	5K	7.5K	10K	12.5K	15K	20K
Burning Position	Universal					
IP Rating	IP66 & IP67					
Temperature Range	-40°C to +60°C (-40°F to +140°F) -20°C to +50°C for emergency variants (-4°F to +122°F)					
Weight	13.2kg (29.1lbs) 16kg (35.2lbs) for emergency variant					
Enclosure	Marine grade aluminium epoxy powder coated, toughened glass, all external fasteners and brackets are marine grade stainless steel					
Unit Colour	Silver (RAL 9006)					
Installation Instructions	Please see document 1250-D-00006 at www.rayteclcd.com					
Battery Care	Please see document number 0010-D-00001 at rayteclcd.com					
Dimensions	See dimension sketches					
Mounting	Stirrup bracket (see dimension sketches)					

Technical Specifications - Emergency

Intelligent Emergency	5K	7.5K	10K	12.5K	15K
Function	Self testing Intelligent Emergency				
System Health Indicator	Bi Colour Indicator LED				
Emergency Duration	180 mins				
Emergency Output (upto)	937 lumens (180 mins duration)				
Emergency Battery	NiMH 6V 4.0Ah				
Emergency Charge Time	20 Hours				

Product Dimensions

MPFL - Standard

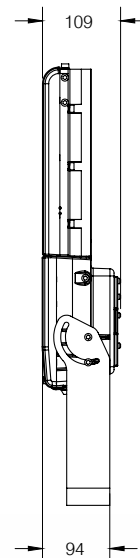
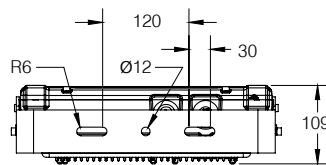
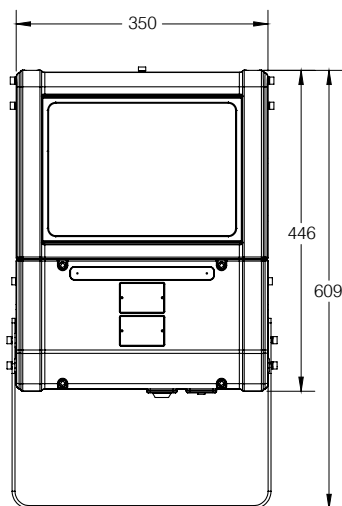

MPFL - Emergency

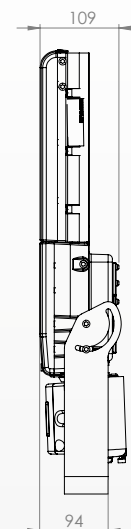
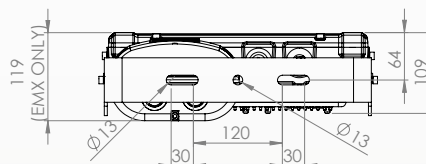
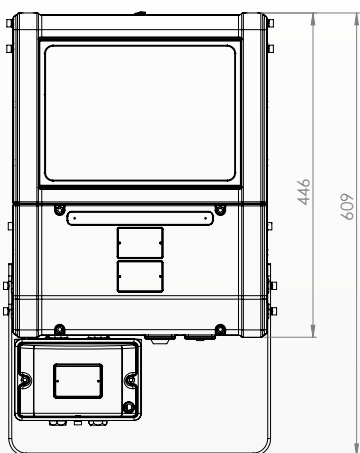

Beam Patterns

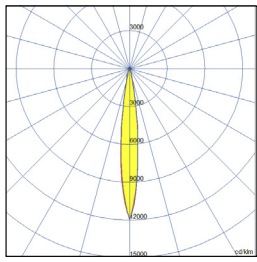

10x10

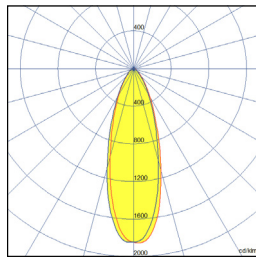

30x30

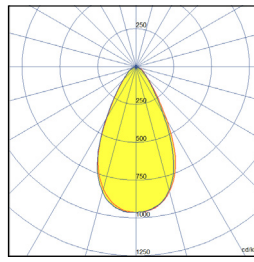

60x60

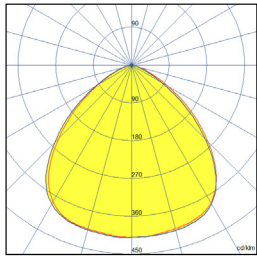

90x90

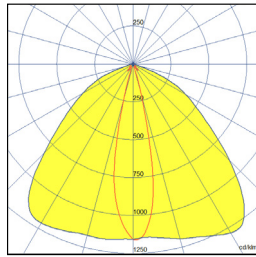

120x15

Part Code Builder

WARRIOR Mid Power Flood

Example - SPI-MPFL15K-W-9090-EMX180

Family	Model	Light Type	Optics	Emergency	CCT	Power	Entry
SPI	MPFL5K	W- White Light	3030	EMX180 (180 minute duration)	Not Stated - 5700K	Not Stated - 150-264Vac	Not Stated - M20
	MPFL7K5		6060		4K - 4000K	110 - 110V-277Vac	M25
	MPFL10K		9090				
	MPFL12K5		12015				
	MPFL15K		1010				
	MPFL20K						

Disclaimer

The information provided in this document was accurate at the time of its creation. However, due to the evolving nature of our products and continuous improvements, there may be changes or updates that occur after its publication.

For the most current and detailed information about our products, please contact our sales team at sales@rayteclcd.com.