

TRS 24-230VUC 2CO ED2**Weidmüller Interface GmbH & Co. KG**

Klingenbergstraße 26

D-32758 Detmold

Germany

www.weidmueller.com

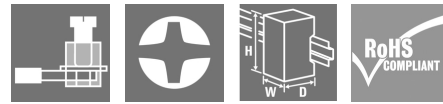
Product image

Similar to illustration

- 2 CO contacts
- Contact material: AgNi
- Unique multi-voltage input from 24 to 230 V UC
- Input voltages from 5 V DC to 230 V UC with coloured marking: AC: red, DC: blue, UC: white

General ordering data

Version	TERMSERIES, Relay module, Number of contacts: 2, CO contact AgNi, Rated control voltage: 24... 230 V UC $\pm 10\%$, Continuous current: 8 A, Screw connection, Test button available: No
Order No.	2662880000
Type	TRS 24-230VUC 2CO ED2
GTIN (EAN)	4050118698190
Qty.	10 pc(s).

Creation date April 11, 2025 2:56:13 PM CEST

Catalogue status 29.03.2025 / We reserve the right to make technical changes.

TRS 24-230VUC 2CO ED2

Weidmüller Interface GmbH & Co. KG

Klingenbergstraße 26

D-32758 Detmold

Germany

www.weidmueller.com

Technical data

Dimensions and weights

Depth	87.8 mm	Depth (inches)	3.457 inch
Height	89.6 mm	Height (inches)	3.528 inch
Width	12.8 mm	Width (inches)	0.504 inch
Net weight	62 g		

Temperatures

Storage temperature	-40 °C...85 °C	Operating temperature	-40 °C...60 °C
Humidity	5-95% relative humidity, T _u = 40°C, without condensation		

Rated data UL

Ambient temperature (operational), max. 60 °C		Connection cross-section AWG, min.	AWG 26
Connection cross-section AWG, max.	AWG 14	Type of conductor	rigid copper conductor, flexible copper conductor
Tightening torque, max.	0.4 Nm	Pollution severity level	2

Control side

Rated control voltage	24...230 V UC ±10 %	Rated current AC	23.5 mA @ 24 V AC, 4.5 mA @ 230 V AC
Rated current DC	22.5 mA @ 24 V DC, 2.0 mA @ 230 V DC	Power rating	540 mW @ 24 V DC, 460 mW @ 230 V DC, 565 mVA @ 24 V AC, 1.0 VA @ 230 V AC
Status indicator	Green LED	Protective circuit	Rectifier
Coil voltage of the replacement relay deviating from the rated control voltage	Yes	Coil voltage of the replacement relay	24 V DC

Load side

Rated switching voltage	250 V AC	Continuous current	8 A
Max. switching frequency at rated load	0.1 Hz	Max. switching voltage, AC	250 V
Max. switching voltage, DC	250 V	Inrush current	15 A / 4 s
AC switching capacity (resistive), max.	2000 VA	DC switching capacity (resistive), max.	192 W @ 24 V
Switch-on delay	≤ 50 ms	Switch-off delay	≤ 50 ms
Contact type	2 CO contact (AgNi)	Mechanical service life	30 x 10 ⁶ switching cycles
Min. switching power	1 mA @ 24 V, 10 mA @ 10 V, 100 mA @ 5 V		

General data

Operating altitude	≤ 2000 m, above sea level		
Rail	TS 35		
Test button available	No		
Mechanical switch position indicator	No		
Colour	black		
UL94 flammability rating component	Component	Housing	
	UL94 flammability rating	V-0	
	Component	Retaining clip	
	UL94 flammability rating	V-0	

Creation date April 11, 2025 2:56:13 PM CEST

Catalogue status 29.03.2025 / We reserve the right to make technical changes.

2

TRS 24-230VUC 2CO ED2

Weidmüller Interface GmbH & Co. KG

Klingenbergstraße 26

D-32758 Detmold

Germany

www.weidmueller.com

Technical data

Insulation coordination

Rated voltage	300 V	Pollution severity	2
Surge voltage category	III	Clearance and creepage distances for control side - load side	≥ 6 mm
Dielectric strength for control side - load side	3.51 kV _{eff} / 1 min.	Type of isolation at input and output	reinforced insulation
Type of isolation at neighbouring contacts	Basic insulation	Dielectric strength to mounting rail	3.51 kV _{eff} / 1 min.
Protection degree	IP20		

Further details of approvals / standards

Certificate No. (DNV)	TAA00001E5	Certificate no. (cULus)	E141197
-----------------------	------------	-------------------------	---------

Connection data

Wire connection method	Screw connection	Stripping length, rated connection	8 mm
Tightening torque, max.	0.4 Nm	Clamping range, rated connection	1.5 mm ²
Clamping range, min.	0.14 mm ²	Clamping range, max.	2.5 mm ²
Wire connection cross section AWG, min.	AWG 26	Wire connection cross section AWG, max.	AWG 14
Wire cross-section, solid, min.	0.14 mm ²	Wire cross-section, solid, max.	2.5 mm ²
Wire cross-section, solid, min. (AWG)	AWG 26	Wire cross-section, solid, max. (AWG)	AWG 14
Wire connection cross section, finely stranded, min.	0.14 mm ²	Wire connection cross section, finely stranded, max.	2.5 mm ²
Wire cross-section, finely stranded, min. (AWG)	AWG 26	Wire cross-section, finely stranded, max. (AWG)	AWG 16
Wire connection cross-section, finely stranded with wire-end ferrules DIN 46228/4, min.	0.25 mm ²	Wire connection cross-section, finely stranded with wire-end ferrules DIN 46228/4, max.	2.5 mm ²
Conductor cross-section, flexible, AEH (DIN 46228-1), min.	0.25 mm ²	Conductor cross-section, flexible, AEH (DIN 46228-1), max.	1.5 mm ²
Wire connection cross section, finely stranded, two clampable wires, min.	0.5 mm ²	Wire cross-section, finely stranded, two clampable wires, max.	1 mm ²
Blade size	SD 0.6 x 3.5		

Classifications

ETIM 6.0	EC001437	ETIM 7.0	EC001437
ETIM 8.0	EC001437	ETIM 9.0	EC001437
ECLASS 9.0	27-37-16-01	ECLASS 9.1	27-37-16-01
ECLASS 10.0	27-37-16-01	ECLASS 11.0	27-37-16-01
ECLASS 12.0	27-37-16-01	ECLASS 13.0	27-37-16-01
ECLASS 14.0	27-37-16-01		

Environmental Product Compliance

RoHS Compliance Status	Compliant with exemption
RoHS Exemption (if applicable/known)	7a, 7cl
REACH SVHC	Lead 7439-92-1
SCIP	9e2cbc49-76d9-4611-b8ec-5b4f549a0aa9

TRS 24-230VUC 2CO ED2

Weidmüller Interface GmbH & Co. KG
 Klingenbergstraße 26
 D-32758 Detmold
 Germany

www.weidmueller.com

Technical data

Approvals

Approvals



Approvals MAMID	https://mdcop.weidmueller.com/mediadelivery/rendition/900_319222/-T1z1mm-S800/ https://mdcop.weidmueller.com/mediadelivery/rendition/900_319228/-T1z1mm-S800/ https://mdcop.weidmueller.com/mediadelivery/rendition/900_319234/-T1z1mm-S800/ https://mdcop.weidmueller.com/mediadelivery/rendition/900_319260/-T1z1mm-S800/
ROHS	Conform
UL File Number Search	UL Website
Certificate no. (cULus)	E141197

Downloads

Approval/Certificate/Document of Conformity	EU Konformitätserklärung / EU Declaration of Conformity
Engineering Data	CAD data – STEP
User Documentation	Beipackzettel / Package Insert – multilingual FL_TERMSERIES_RCL2CO_LOAD_GUIDE
Catalogues	Catalogues in PDF-format

TRS 24-230VUC 2CO ED2

Weidmüller Interface GmbH & Co. KG
 Klängenbergstraße 26
 D-32758 Detmold
 Germany

www.weidmueller.com

Drawings

Wiring diagram

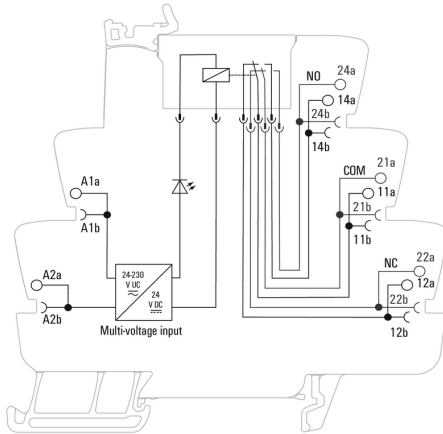

Graph

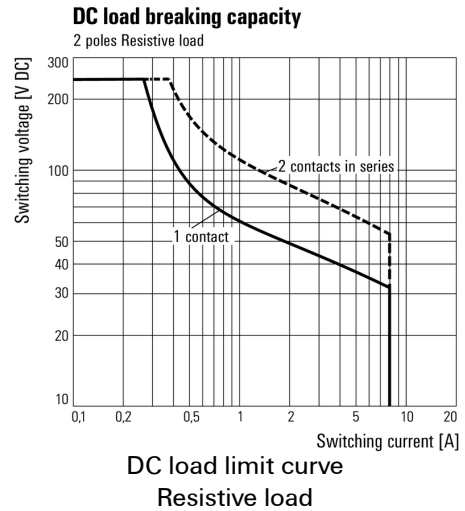

Graph

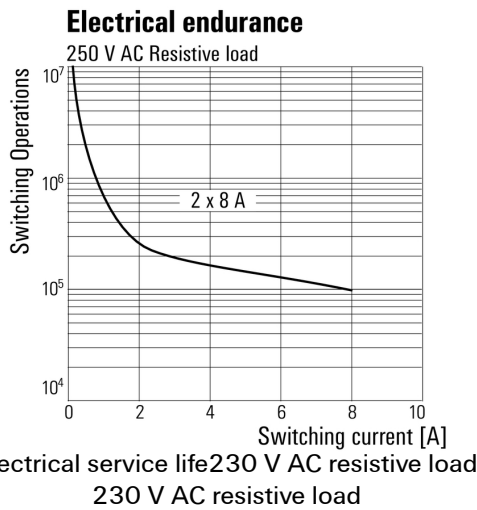

Graph

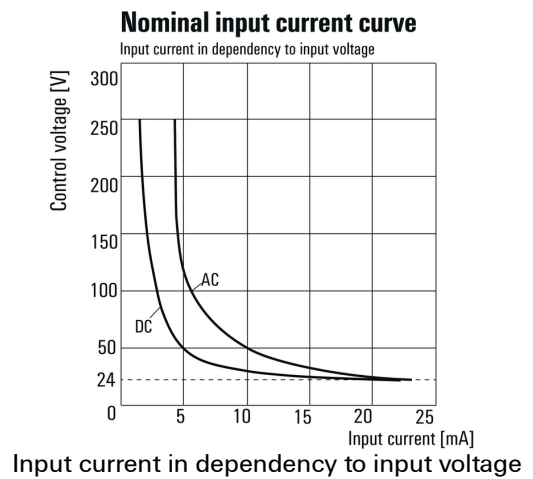

Dimensional drawing

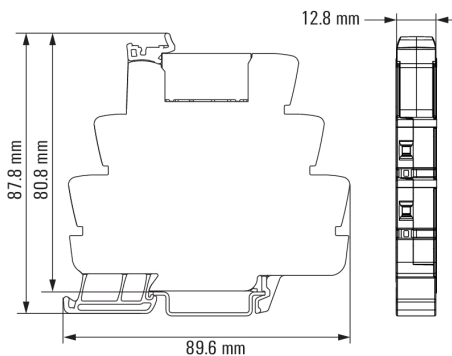

TRS 24-230VUC 2CO ED2

Weidmüller Interface GmbH & Co. KG

Klingenbergstraße 26

D-32758 Detmold

Germany

www.weidmueller.com

Accessories

Supply module



Space-saving supply modules

Our supply terminals enable potentials to be fed at the input – e.g. neutral or minus potentials – or switched potentials to be fed at the output. In conjunction with precisely fitting cross-connections from the TEMRSERIES, the connections for the cables on the relay module remain free for the cables on the relay module remain free for actuators or sensors. No additional feed-through terminal blocks are required, resulting in huge space savings in the panel. At the same time, the wiring is simplified as no double wire-end ferrules are required for the potential feed.

General ordering data

Type	TXZ SUPPLY	Version
Order No.	1240790000	TERMSERIES, Supply module, Number of contacts: 5, , Continuous
GTIN (EAN)	4050118028164	current: 10 A, Tension-clamp connection
Qty.	10 pc(s).	
Type	TXS SUPPLY	Version
Order No.	1240780000	TERMSERIES, Supply module, Number of contacts: 5, , Continuous
GTIN (EAN)	4050118028140	current: 10 A, Screw connection
Qty.	10 pc(s).	
Type	TXP SUPPLY	Version
Order No.	2618940000	TERMSERIES, Supply module, Number of contacts: 5, , Continuous
GTIN (EAN)	4050118667592	current: 10 A, PUSH IN
Qty.	10 pc(s).	

Slotted screwdriver



VDE insulated screwdriver sets, for working on live parts up to 1000 V AC and 1500 V DC, DIN EN 60900. IEC 900. Each piece is "GS" safety tested. Blade made from fully hardened, high-alloy chromium-vanadium-molybdenum steel, gun-metal finish.

General ordering data

Type	SDIS SLIM 0.6X3.5X100	Version
Order No.	2749610000	Mounting tool, Blade width (B): 3.5 mm, Blade length: 100 mm, Blade
GTIN (EAN)	4050118896350	thickness (A): 0.6 mm
Qty.	1 pc(s).	

TRS 24-230VUC 2CO ED2

Weidmüller Interface GmbH & Co. KG
 Klingenbergstraße 26
 D-32758 Detmold
 Germany

www.weidmueller.com

Accessories

Interface adapters

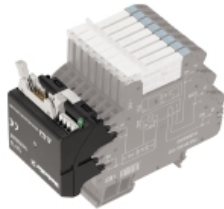

Faster signal wiring with less space

To reduce wiring times, pre-assembled cables are used between the control system and the interface level and are simply connected to the TERMSERIES adapter. This enables throughput times in electrical cabinet building to be significantly reduced. The adapter has a universal fit and offers a genuine space advantage in interaction with the TERMSERIES products with identical contours.

- Reduced wiring time due to plug-and-play concept with pre-assembled cables
- Can be applied to the input and output sides of the TERMSERIES
- Ready for plus and minus switching logic
- High space-saving due to universal fit to other TERMSERIES products

General ordering data

Type	TIAL F10	Version
Order No.	1463540000	TERMSERIES, Adapter, 10-pole plug according to DIN EN 60603-13,
GTIN (EAN)	4050118323559	long locking lever, Number of signal paths: 8, Rated voltage DC : 24 V,
Qty.	1 pc(s).	Rated current (per signal path): 125 mA

WS 12/6



WS/ DEK

MultiMark terminal markers use an innovative composite material made from two components. The hard base contour of the marker snaps securely into the connector. The elastic surface finish makes the marker easy to mount. This specially punched material enables the strips to be stretched to accommodate the slight variations in spacing that tend to add up, especially with long terminal blocks. Another advantage: the excellent printability of the surface material guarantees durable and wear-resistant labelling. A print resolution of 300 dpi also produces a very legible script.

Your benefits with MultiMark

- Firm hold and durable printing
- Continuous strips save installation time
- Easy mounting thanks to an innovative composite material
- Large label field for optimal legibility
- High flexibility thanks to manufacturer independence

General ordering data

Type	WS 12/6 MM WS	Version
Order No.	2007200000	WS, Terminal marker, 12 x 6 mm, Weidmueller, white
GTIN (EAN)	4050118391886	
Qty.	600 pc(s).	

TRS 24-230VUC 2CO ED2

Weidmüller Interface GmbH & Co. KG

Klingenbergstraße 26

D-32758 Detmold

Germany

www.weidmueller.com

Accessories

Cross-connections



Adjustable cross-connections

Increase the flexibility of your cross-connections. The TERMSERIES CROSS-CONNECTION (TCC) enables individually adjustable cross-connections with up to 51 poles. The maximum number of pluggable poles has been increased to 32 poles. The strip material can be shortened to the required length very easily. The cross-connectors convince thanks to their easy handling and visibility as well as their universal connection possibilities. An additional web prevents the spring from deforming during assembly.

- Individually adjustable cross-connection with 51 poles
- Additional bar to avoid deformation of the spring
- Increased cross-connection – up to 32 poles possible
- Vibration resistance

General ordering data

Type	TCC 6.4/10 BL	Version
Order No.	2556440000	TERMSERIES, Cross-connector
GTIN (EAN)	4050118566956	
Qty.	10 pc(s).	
Type	TCC 6.4/51 BL	Version
Order No.	2556450000	TERMSERIES, Cross-connector
GTIN (EAN)	4050118566963	
Qty.	10 pc(s).	
Type	TCC 6.4/51 OR	Version
Order No.	2556370000	TERMSERIES, Cross-connector
GTIN (EAN)	4050118566680	
Qty.	10 pc(s).	
Type	TCC 6.4/2 BL	Version
Order No.	2556430000	TERMSERIES, Cross-connector
GTIN (EAN)	4050118566949	
Qty.	10 pc(s).	
Type	TCC 12.8/26 RD	Version
Order No.	2556420000	TERMSERIES, Cross-connector
GTIN (EAN)	4050118566932	
Qty.	10 pc(s).	
Type	TCC 12.8/26 BL	Version
Order No.	2556460000	TERMSERIES, Cross-connector
GTIN (EAN)	4050118566970	
Qty.	10 pc(s).	
Type	TCC 6.4/51 BK	Version
Order No.	2556490000	TERMSERIES, Cross-connector
GTIN (EAN)	4050118567007	
Qty.	10 pc(s).	
Type	TCC 6.4/2 OR	Version
Order No.	2556350000	TERMSERIES, Cross-connector
GTIN (EAN)	4050118566826	
Qty.	10 pc(s).	

TRS 24-230VUC 2CO ED2

Weidmüller Interface GmbH & Co. KG
 Klingenbergstraße 26
 D-32758 Detmold
 Germany

www.weidmueller.com

Accessories

Type	TCC 6.4/10 OR	Version
Order No.	2556360000	TERMSERIES, Cross-connector
GTIN (EAN)	4050118566673	
Qty.	10 pc(s).	
Type	TCC 6.4/10 BK	Version
Order No.	2556480000	TERMSERIES, Cross-connector
GTIN (EAN)	4050118566994	
Qty.	10 pc(s).	
Type	TCC 6.4/10 RD	Version
Order No.	2556400000	TERMSERIES, Cross-connector
GTIN (EAN)	4050118566918	
Qty.	10 pc(s).	
Type	TCC 6.4/51 RD	Version
Order No.	2556410000	TERMSERIES, Cross-connector
GTIN (EAN)	4050118566925	
Qty.	10 pc(s).	
Type	TCC 6.4/2 BK	Version
Order No.	2556470000	TERMSERIES, Cross-connector
GTIN (EAN)	4050118566987	
Qty.	10 pc(s).	
Type	TCC 12.8/26 BK	Version
Order No.	2556500000	TERMSERIES, Cross-connector
GTIN (EAN)	4050118567014	
Qty.	10 pc(s).	
Type	TCC 6.4/2 RD	Version
Order No.	2556390000	TERMSERIES, Cross-connector
GTIN (EAN)	4050118566901	
Qty.	10 pc(s).	
Type	TCC 12.8/26 OR	Version
Order No.	2556380000	TERMSERIES, Cross-connector
GTIN (EAN)	4050118566697	
Qty.	10 pc(s).	

TRS 24-230VUC 2CO ED2

Weidmüller Interface GmbH & Co. KG

Klingenbergstraße 26

D-32758 Detmold

Germany

www.weidmueller.com

Accessories

Partition plate



Versatile separation plates

Separation plates can be used to group together signals visually, to electrically isolate modules and to insert markings for a better overview. This makes them a particularly versatile accessory. Separation plates increase the clearance and creepage distances between two modules, thus increasing the rated insulation voltage between two modules to up to 600 V. Double separation plates can be marked with WAD5 or WS10/5 markers and enable continuous cross-connections. Installation is made easier with the perforations to individually break out the cross-connection channels.

- Partition plates visually separates groups from each other
- Indentations for individual breaking out the crossconnection channels
- Partition plates isolates between two modules by increasing the clearance and creepage distances of up to 600 V

General ordering data

Type	TW TXS/TXZ R3.2	Version	
Order No.	1240800000	TERMSERIES, Partition plate	
GTIN (EAN)	4050118028188		
Qty.	10 pc(s).		

TRS 24-230VUC 2CO ED2

Weidmüller Interface GmbH & Co. KG

Klingenbergstraße 26

D-32758 Detmold

Germany

www.weidmueller.com

Accessories

Blank



WS markers are the perfect match for the W-series connectors. Thanks to their system compatibility, the WS tags can also be used with the I-series and the Z-series. The large marking surfaces do not only permit long character strings but also multi-line text. WS markers are ideal for labels with long, customised character strings. Thanks to the proven MultiCard format, printing with PrintJet CONNECT oder/or Plotter is possible.

- Can be fitted in strips or individually
- Markers in proven MultiCard format

For custom printing: Please send us a file of our labeling software M-Print PRO or M-Print PRO Online (without installation) for your labeling specifications.

General ordering data

Type	WS 10/6 M MC NE WS	Version
Order No.	1818400000	WS, Terminal marker, 10 x 6 mm, Pitch in mm (P): 6.00 Weidmueller,
GTIN (EAN)	4032248310876	Allen-Bradley, white
Qty.	600 pc(s).	

Blank



WS markers are the perfect match for the W-series connectors. Thanks to their system compatibility, the WS tags can also be used with the I-series and the Z-series. The large marking surfaces do not only permit long character strings but also multi-line text. WS markers are ideal for labels with long, customised character strings. Thanks to the proven MultiCard format, printing with PrintJet CONNECT oder/or Plotter is possible.

- Can be fitted in strips or individually
- Markers in proven MultiCard format

For custom printing: Please send us a file of our labeling software M-Print PRO or M-Print PRO Online (without installation) for your labeling specifications.

General ordering data

Type	WS 10/12 MC NE WS	Version
Order No.	1905970000	WS, Terminal marker, 10 x 12 mm, Pitch in mm (P): 12.00
GTIN (EAN)	4032248528127	Weidmueller, white
Qty.	300 pc(s).	

TRS 24-230VUC 2CO ED2

Weidmüller Interface GmbH & Co. KG
Klingenbergstraße 26
D-32758 Detmold
Germany

www.weidmueller.com

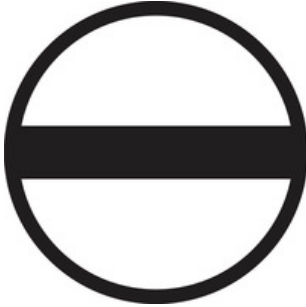
Accessories**Slotted screwdriver**

Slotted screwdriver with rounded blade SD DIN 5265,
ISO 2380/2, output to DIN 5264, ISO 2380/1.
ChromTop tip, SoftFinish grip

General ordering data

Type	SDS 0.6X3.5X100	Version
Order No.	2749340000	Screwdriver, Blade width (B): 3.5 mm, Blade length: 100 mm, Blade
GTIN (EAN)	4050118895568	thickness (A): 0.6 mm
Qty.	1 pc(s).	

TRS 24-230VUC 2CO ED2

Weidmüller Interface GmbH & Co. KG
 Klingenbergstraße 26
 D-32758 Detmold
 Germany

www.weidmueller.com

Drawings

Miscellaneous

Type code TERMSERIES electromechanical relay versions

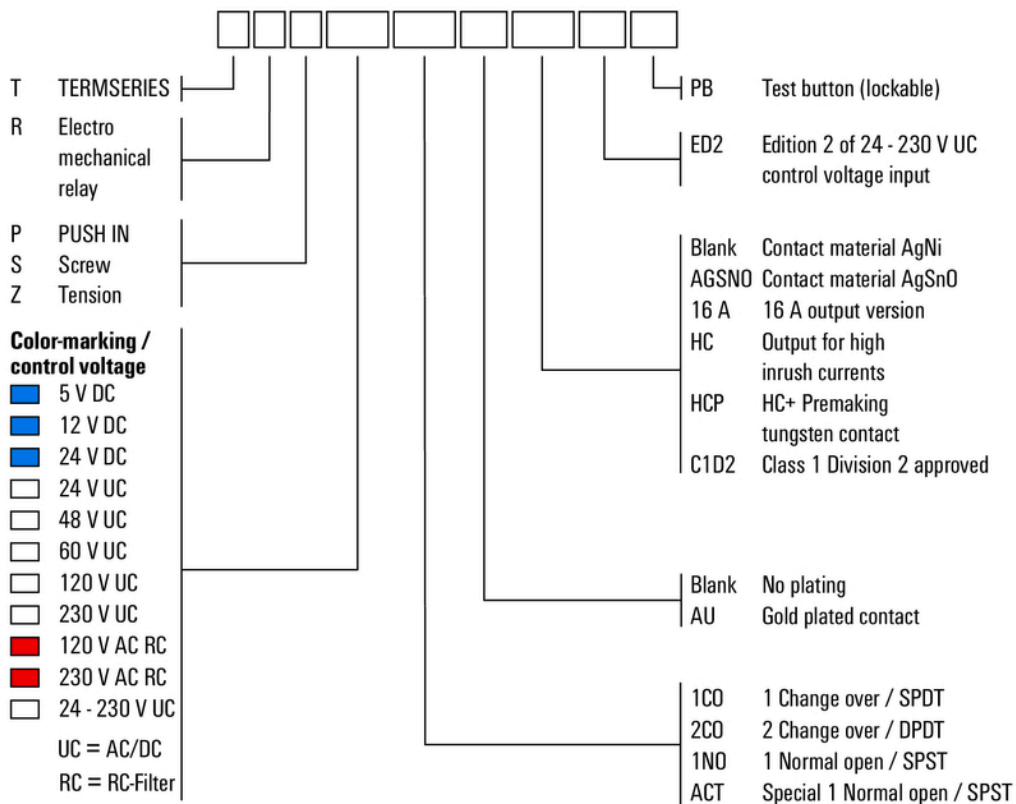

Type codes